

**EASYTRIM REVEALS**

1-877-973-8746  
 www.easytrimreveals.com  
 info@easytrimreveals.com

**QuickPanel PROFILES:**

- QP.0: WINDOW DRIP CAP FLASHING (COLOR MATCH)
  - QP.0-RSF: REVERSE SILL FLASHING (COLOR MATCH)
  - QP.1: CONTINUOUS PERFORATED VENTED FLASHING (BLACK)
  - QP.2: ARROW OUTSIDE CORNER ASSEMBLY (BP. GRAY)
  - QP.3: INSIDE CORNER (COLOR MATCH)
  - QP.4: PERIMETER STARTER TRIM ASSEMBLY (BP. COMMERCIAL BROWN)
  - QP.5: VERTICAL MAINBODY ASSEMBLY (BP. TAUPE)
  - QP.6: RAINSCREEN FURRING SPACERS (CHARCOAL)
  - QP.7: CONTINUOUS METAL FLASHING (BROWN)
  - QP.8: HORIZONTAL MAINBODY ASSEMBLY (BP. WHITE)
  - QP.9: SOFFIT TERMINATION ASSEMBLY (BP. BLUE)
  - QP.10: HORIZONTAL WINDOW SILL ASSEMBLY (BP. BEIGE)
  - QP.11: VERTICAL WINDOW SIDES ASSEMBLY (BP. RED)
  - QP.12: WALL PENETRATION ASSEMBLY (BP. GREEN)
  - QP.13: MULTI-ANGLE INSIDE CORNER ASSEMBLY (BP. COLOR MATCH)
  - QP.14: MULTI-ANGLE OUTSIDE CORNER ASSEMBLY (BP. COLOR MATCH)
  - QP.15: PERFORATED VENTED SOFFIT PLATE (COLOR MATCH)
  - QP.16: VERTICAL TERMINATION ASSEMBLY (BP. ORANGE)
  - QP.17: CORNER TERMINATION ASSEMBLY (BP. COLOR MATCH)
  - QP.18: CONTINUOUS COMPRESSION METAL FLASHING
  - QP.19: HORIZONTAL COMPRESSION ASSEMBLY
- 4mm ACM PANEL  
 QuickPanel WEATHER SEALED SCREWS  
 QuickPanel WEATHER TAPE  
 TREMCO SPECTRUM 1 SILICONE ADHESIVE  
 [NOTE: BP = BACKPLATE]

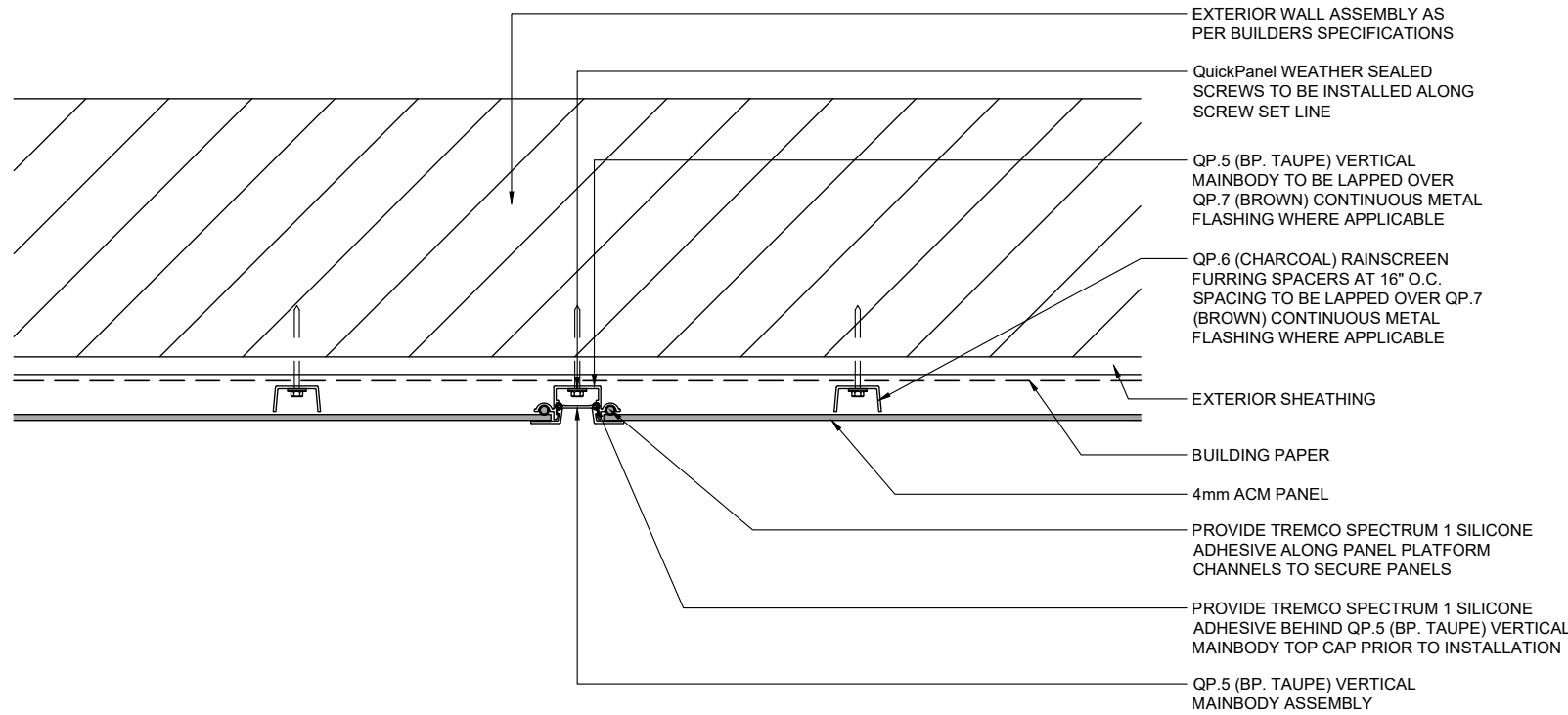

**1** QuickPanel TYPICAL VERTICAL SECTION  
 SCALE: 3" = 1'-0"

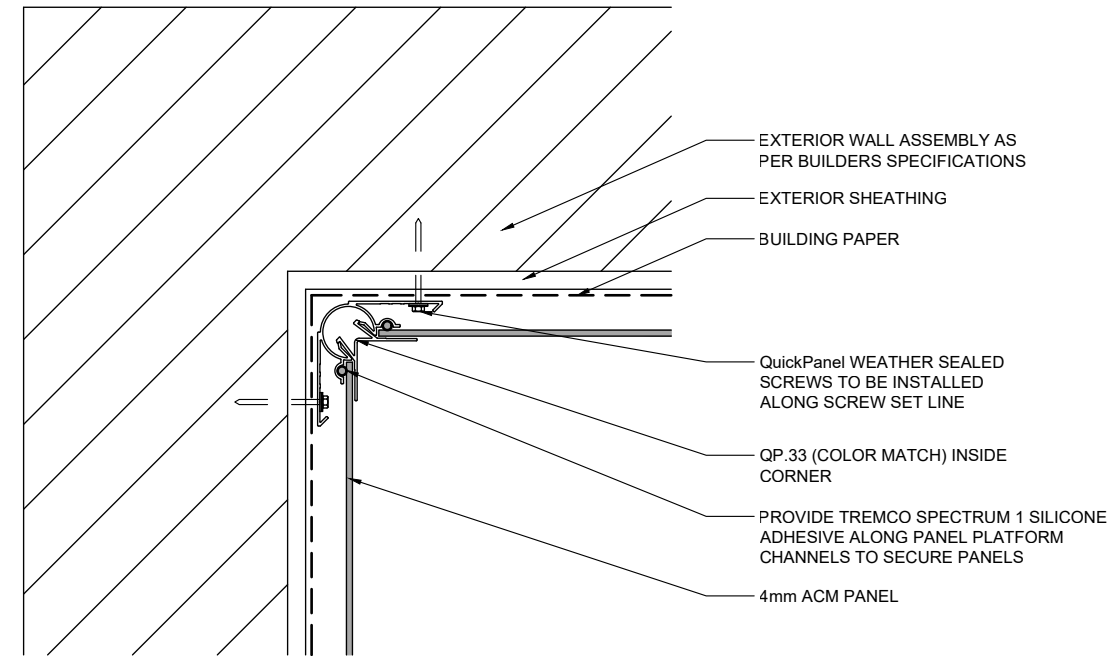

**3** QuickPanel TYPICAL INSIDE CORNER  
 SCALE: 3" = 1'-0"

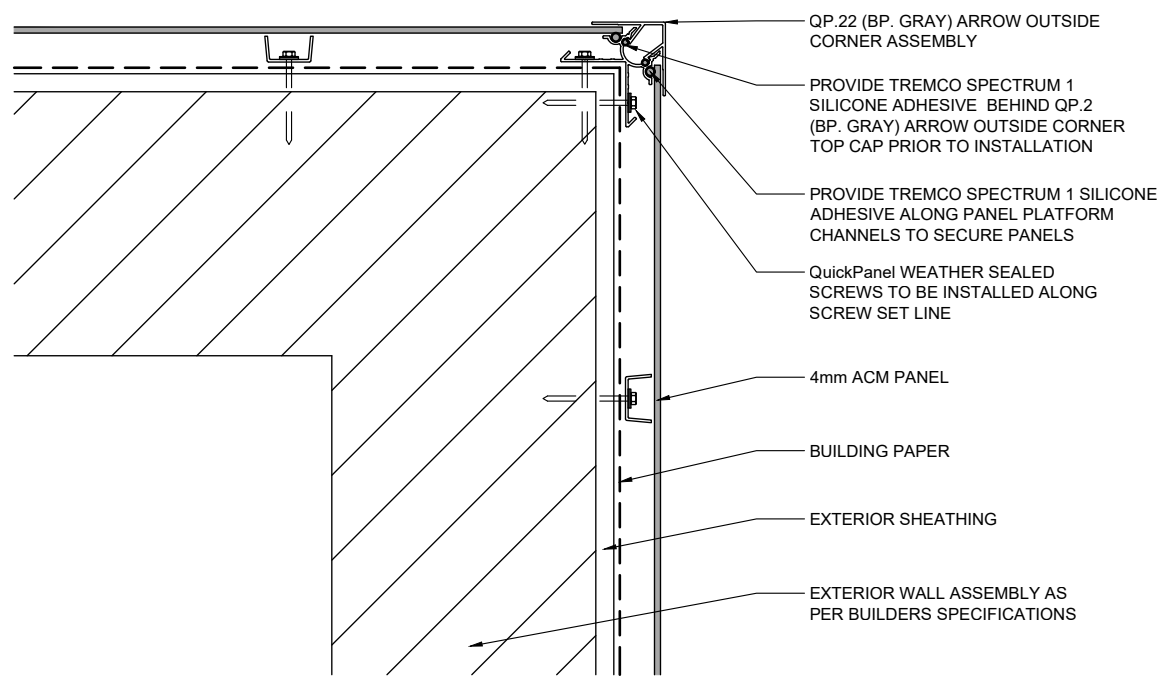

**2** QuickPanel TYPICAL OUTSIDE CORNER  
 SCALE: 3" = 1'-0"

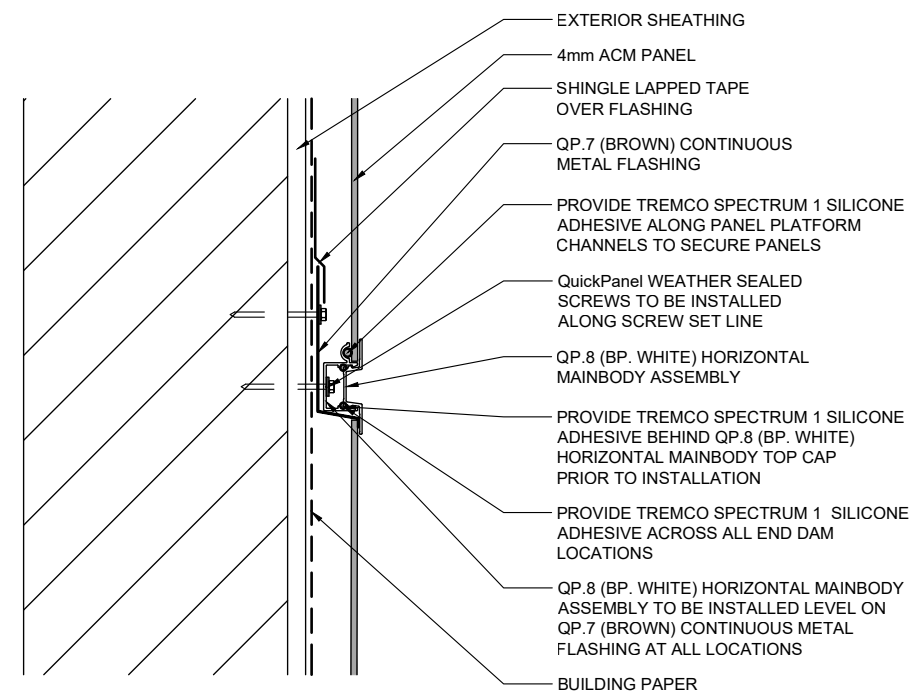

**4** QuickPanel TYPICAL HORIZONTAL SECTION  
 SCALE: 3" = 1'-0"

**4mm ACM QuickPanel System by EasyTrim Reveals**

**QuickPanel System Details**

The contractor / builder must verify all dimensions on the job and report any discrepancy to the designer before proceeding with the work. Drawings are NOT to be scaled. All drawings and specifications are instruments of service and the copyright property of the designer and must be returned upon request.

DRAWN / REVISED BY:	REVIEWED BY:
DATE ISSUED:	DRAWING NUMBER:
PROJECT NUMBER:	<b>A1</b>
SCALE:	

EASYTRIM REVEALS

1-877-973-8746  
 www.easytrimreveals.com  
 info@easytrimreveals.com

QuickPanel PROFILES:

- QP.0: WINDOW DRIP CAP FLASHING (COLOR MATCH)
  - QP.0-RSF: REVERSE SILL FLASHING (COLOR MATCH)
  - QP.1: CONTINUOUS PERFORATED VENTED FLASHING (BLACK)
  - QP.2: ARROW OUTSIDE CORNER ASSEMBLY (BP. GRAY)
  - QP.3: INSIDE CORNER (COLOR MATCH)
  - QP.4: PERIMETER STARTER TRIM ASSEMBLY (BP. COMMERCIAL BROWN)
  - QP.5: VERTICAL MAINBODY ASSEMBLY (BP. TAUPE)
  - QP.6: RAINSCREEN FURRING SPACERS (CHARCOAL)
  - QP.7: CONTINUOUS METAL FLASHING (BROWN)
  - QP.8: HORIZONTAL MAINBODY ASSEMBLY (BP. WHITE)
  - QP.9: SOFFIT TERMINATION ASSEMBLY (BP. BLUE)
  - QP.10: HORIZONTAL WINDOW SILL ASSEMBLY (BP. BEIGE)
  - QP.11: VERTICAL WINDOW SIDES ASSEMBLY (BP. RED)
  - QP.12: WALL PENETRATION ASSEMBLY (BP. GREEN)
  - QP.13: MULTI-ANGLE INSIDE CORNER ASSEMBLY (BP. COLOR MATCH)
  - QP.14: MULTI-ANGLE OUTSIDE CORNER ASSEMBLY (BP. COLOR MATCH)
  - QP.15: PERFORATED VENTED SOFFIT PLATE (COLOR MATCH)
  - QP.16: VERTICAL TERMINATION ASSEMBLY (BP. ORANGE)
  - QP.17: CORNER TERMINATION ASSEMBLY (BP. COLOR MATCH)
  - QP.18: CONTINUOUS COMPRESSION METAL FLASHING
  - QP.19: HORIZONTAL COMPRESSION ASSEMBLY
- 4mm ACM PANEL  
 QuickPanel WEATHER SEALED SCREWS  
 QuickPanel WEATHER TAPE  
 TREMCO SPECTRUM 1 SILICONE ADHESIVE  
 [NOTE: BP = BACKPLATE]

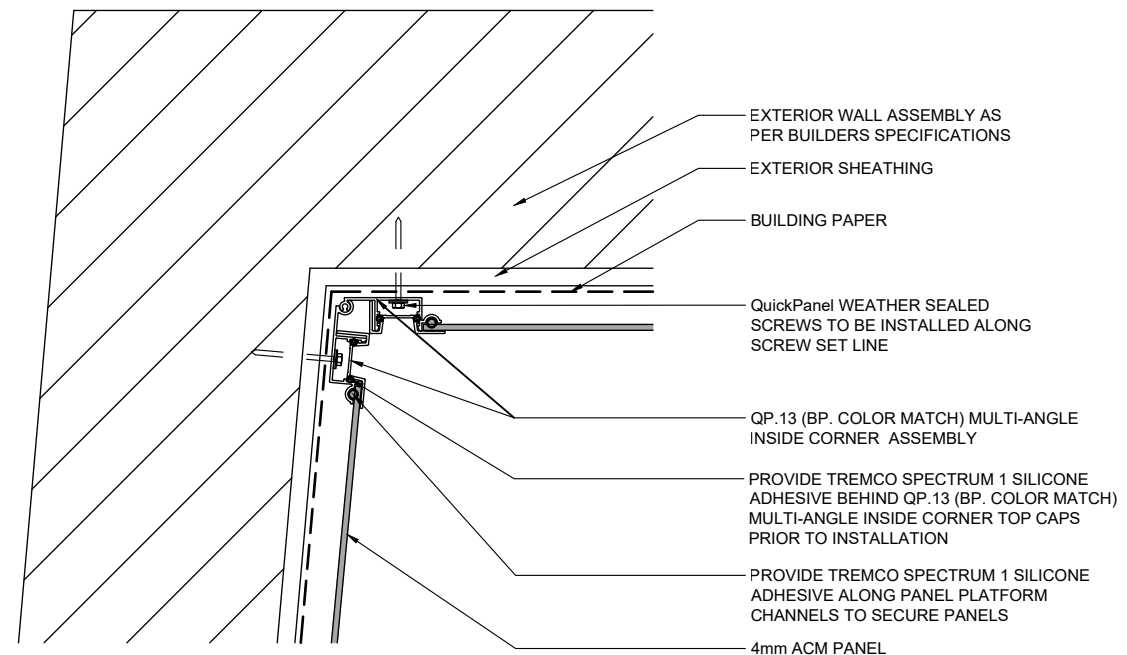

5 QuickPanel TYPICAL MULTI-ANGLE INSIDE CORNER  
 SCALE: 3" = 1'-0"

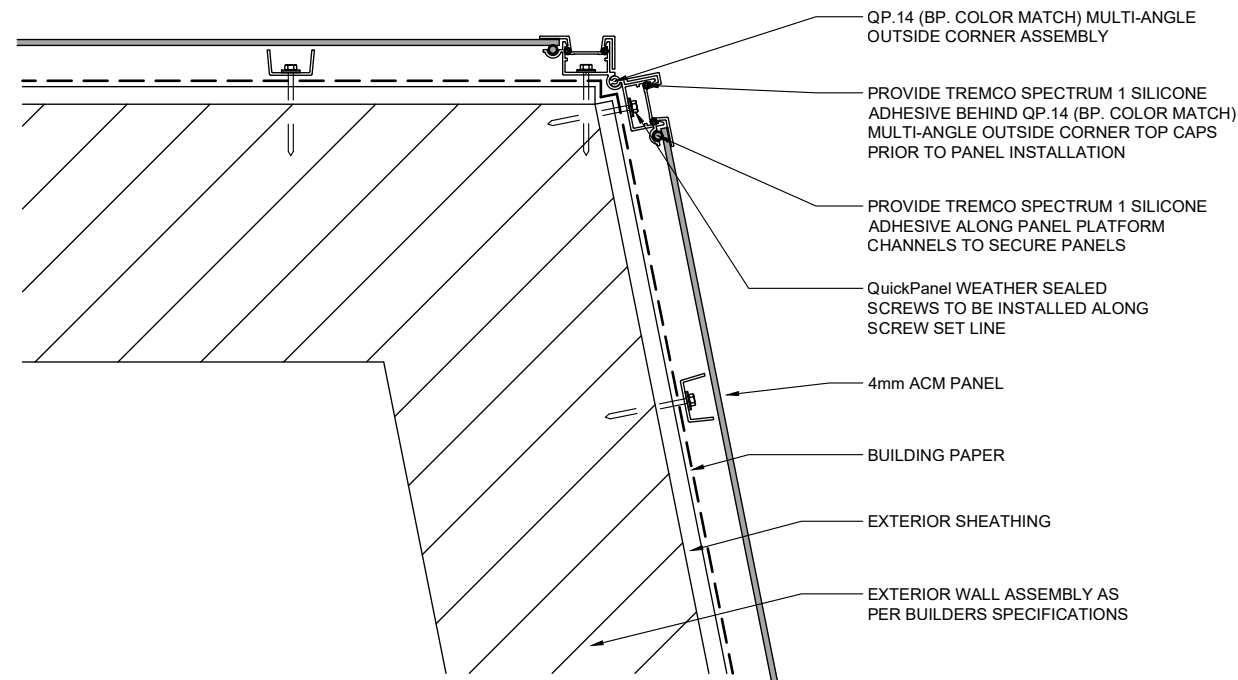

6 QuickPanel TYPICAL MULTI-ANGLE OUTSIDE CORNER  
 SCALE: 3" = 1'-0"

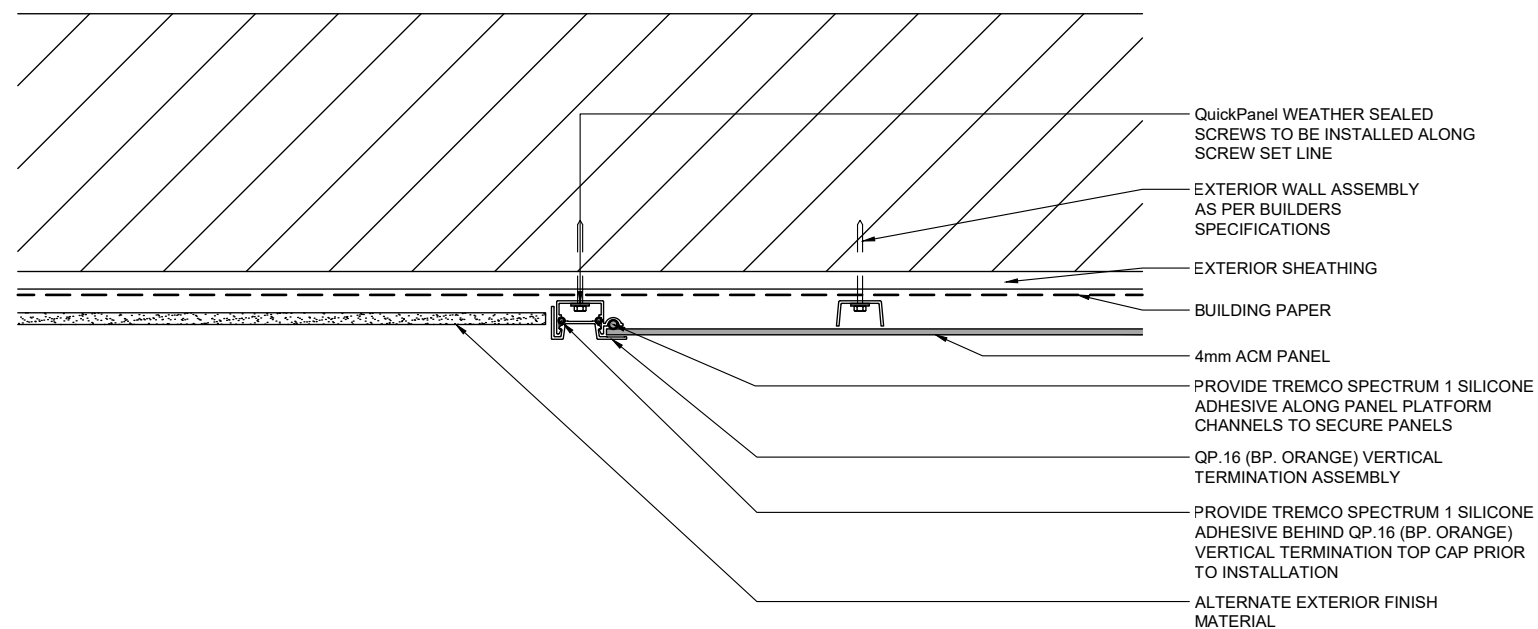

7 QuickPanel TYPICAL VERTICAL MATERIAL TRANSITION SECTION  
 SCALE: 3" = 1'-0"

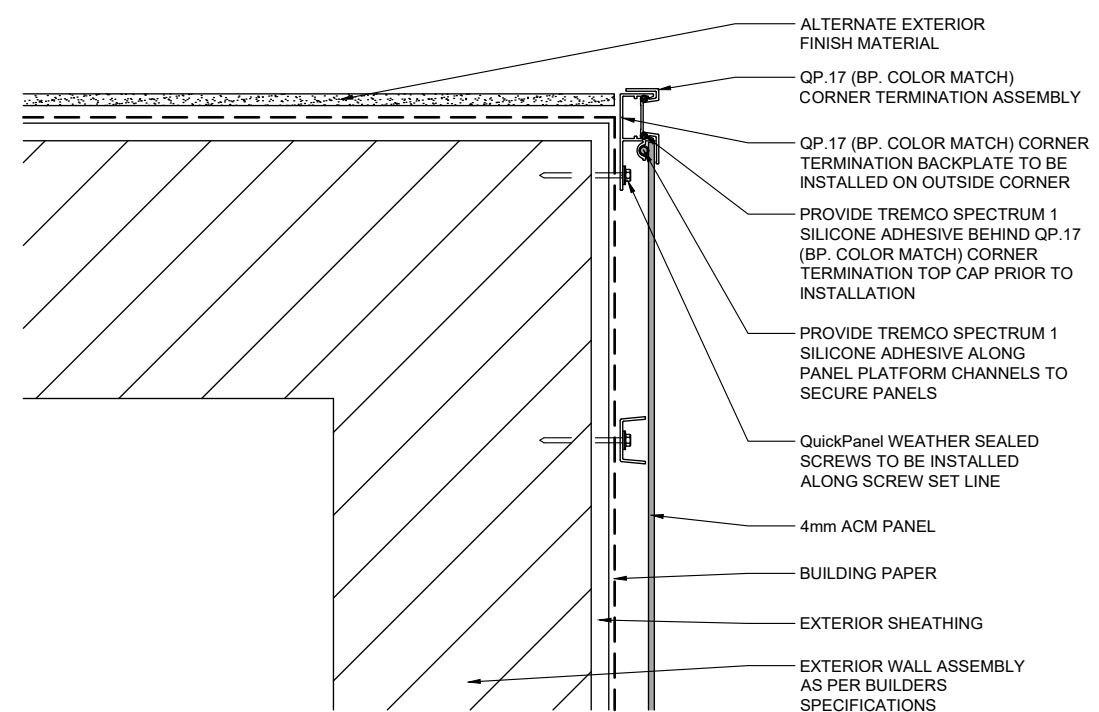

8 QuickPanel TYPICAL OUTSIDE CORNER MATERIAL TRANSITION  
 SCALE: 3" = 1'-0"

4mm ACM  
 QuickPanel System  
 by EasyTrim Reveals

QuickPanel System  
 Details

The contractor / builder must verify all dimensions on the job and report any discrepancy to the designer before proceeding with the work. Drawings are NOT to be scaled. All drawings and specifications are instruments of service and the copyright property of the designer and must be returned upon request.

DRAWN / REVISED BY:	REVIEWED BY:
DATE ISSUED:	DRAWING NUMBER:
PROJECT NUMBER:	<b>A2</b>
SCALE:	

EASYTRIM REVEALS

1-877-973-8746  
 www.easytrimreveals.com  
 info@easytrimreveals.com

QuickPanel PROFILES:

- QP.0: WINDOW DRIP CAP FLASHING (COLOR MATCH)
  - QP.0-RSF: REVERSE SILL FLASHING (COLOR MATCH)
  - QP.1: CONTINUOUS PERFORATED VENTED FLASHING (BLACK)
  - QP.2: ARROW OUTSIDE CORNER ASSEMBLY (BP. GRAY)
  - QP.3: INSIDE CORNER (COLOR MATCH)
  - QP.4: PERIMETER STARTER TRIM ASSEMBLY (BP. COMMERCIAL BROWN)
  - QP.5: VERTICAL MAINBODY ASSEMBLY (BP. TAUPE)
  - QP.6: RAINSCREEN FURRING SPACERS (CHARCOAL)
  - QP.7: CONTINUOUS METAL FLASHING (BROWN)
  - QP.8: HORIZONTAL MAINBODY ASSEMBLY (BP. WHITE)
  - QP.9: SOFFIT TERMINATION ASSEMBLY (BP. BLUE)
  - QP.10: HORIZONTAL WINDOW SILL ASSEMBLY (BP. BEIGE)
  - QP.11: VERTICAL WINDOW SIDES ASSEMBLY (BP. RED)
  - QP.12: WALL PENETRATION ASSEMBLY (BP. GREEN)
  - QP.13: MULTI-ANGLE INSIDE CORNER ASSEMBLY (BP. COLOR MATCH)
  - QP.14: MULTI-ANGLE OUTSIDE CORNER ASSEMBLY (BP. COLOR MATCH)
  - QP.15: PERFORATED VENTED SOFFIT PLATE (COLOR MATCH)
  - QP.16: VERTICAL TERMINATION ASSEMBLY (BP. ORANGE)
  - QP.17: CORNER TERMINATION ASSEMBLY (BP. COLOR MATCH)
  - QP.18: CONTINUOUS COMPRESSION METAL FLASHING
  - QP.19: HORIZONTAL COMPRESSION ASSEMBLY
- 4mm ACM PANEL  
 QuickPanel WEATHER SEALED SCREWS  
 QuickPanel WEATHER TAPE  
 TREMCO SPECTRUM 1 SILICONE ADHESIVE  
 [NOTE: BP = BACKPLATE]

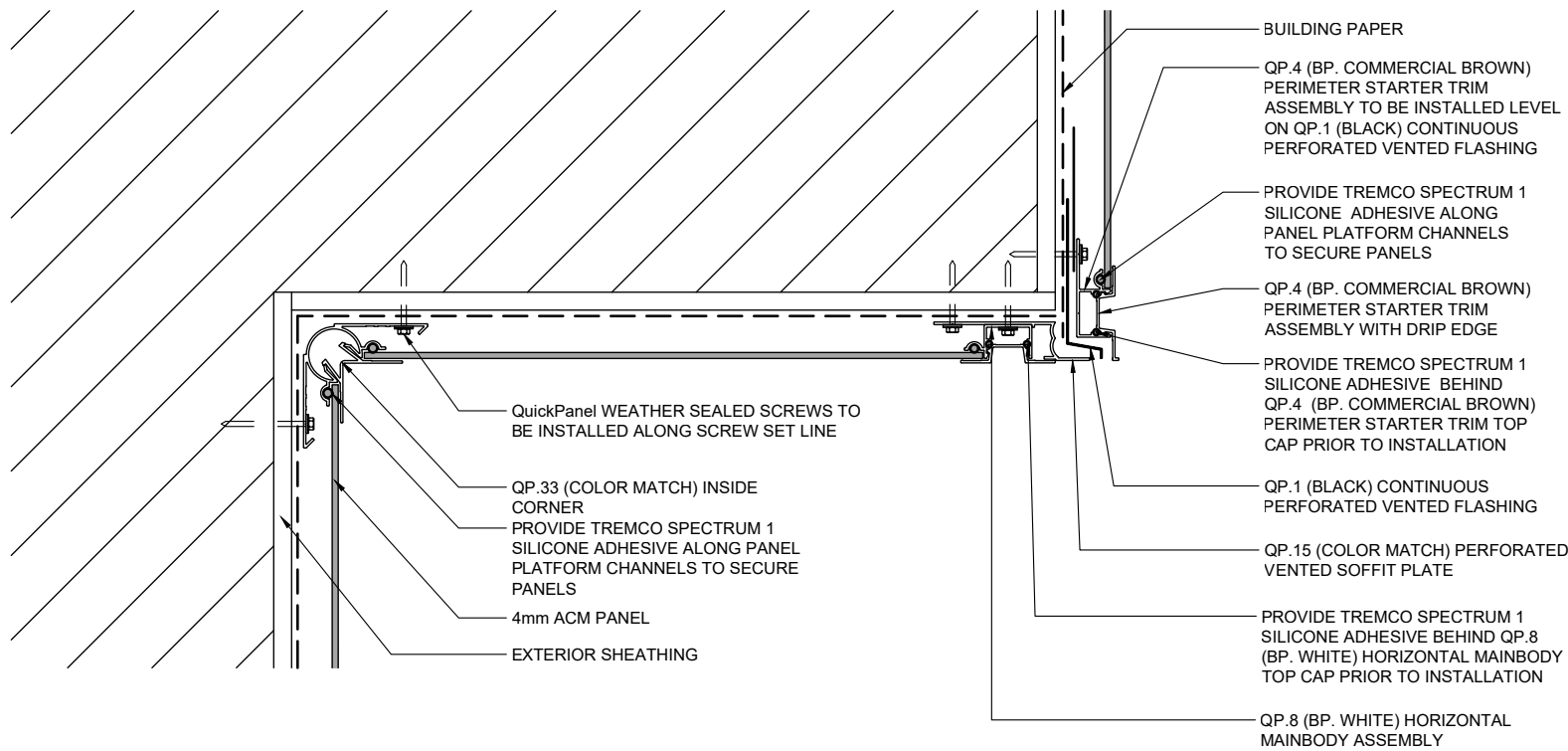

9A QuickPanel TYPICAL SOFFIT SECTION

A3 SCALE: 3" = 1'-0"

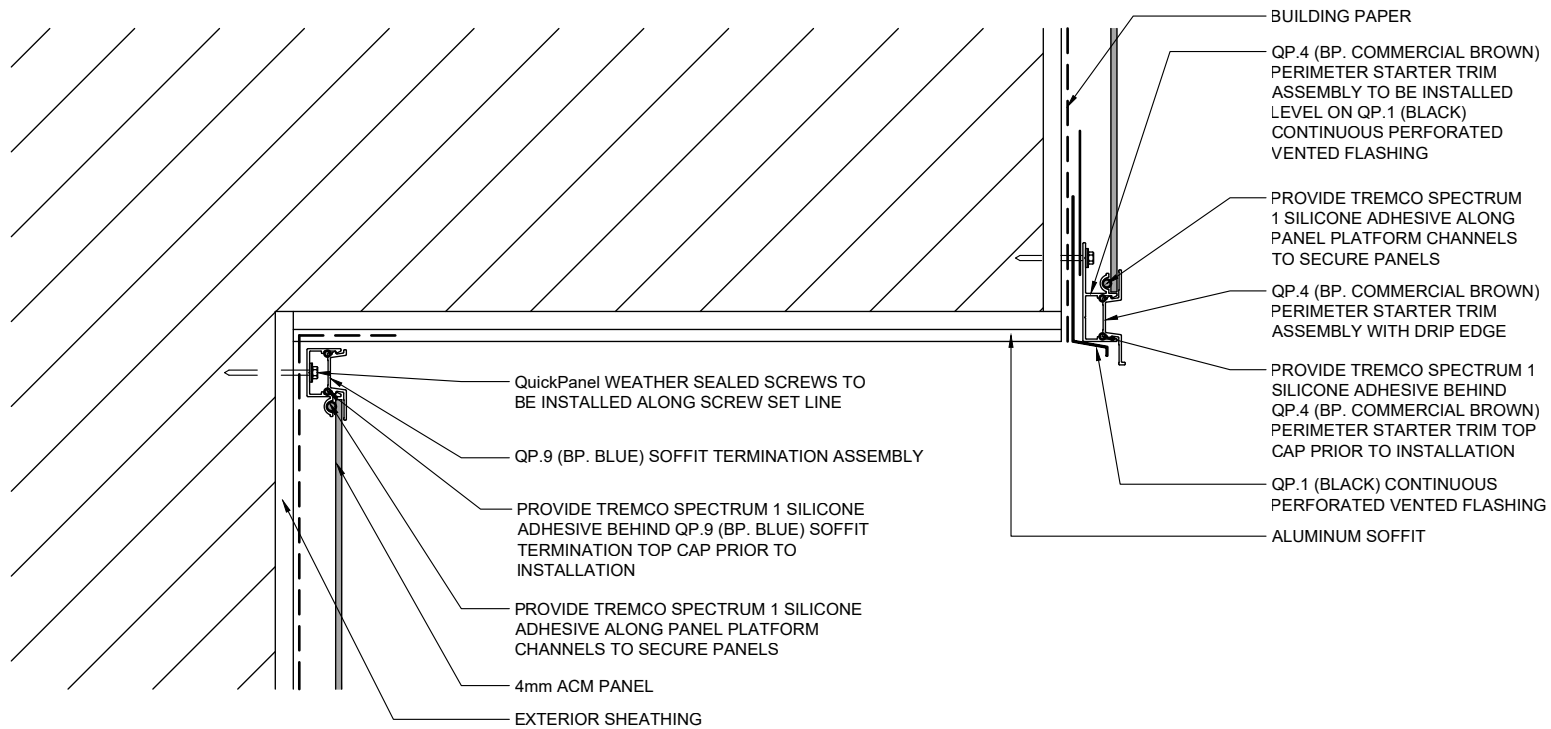

9B QuickPanel ALTERNATE SOFFIT SECTION

A3 SCALE: 3" = 1'-0"

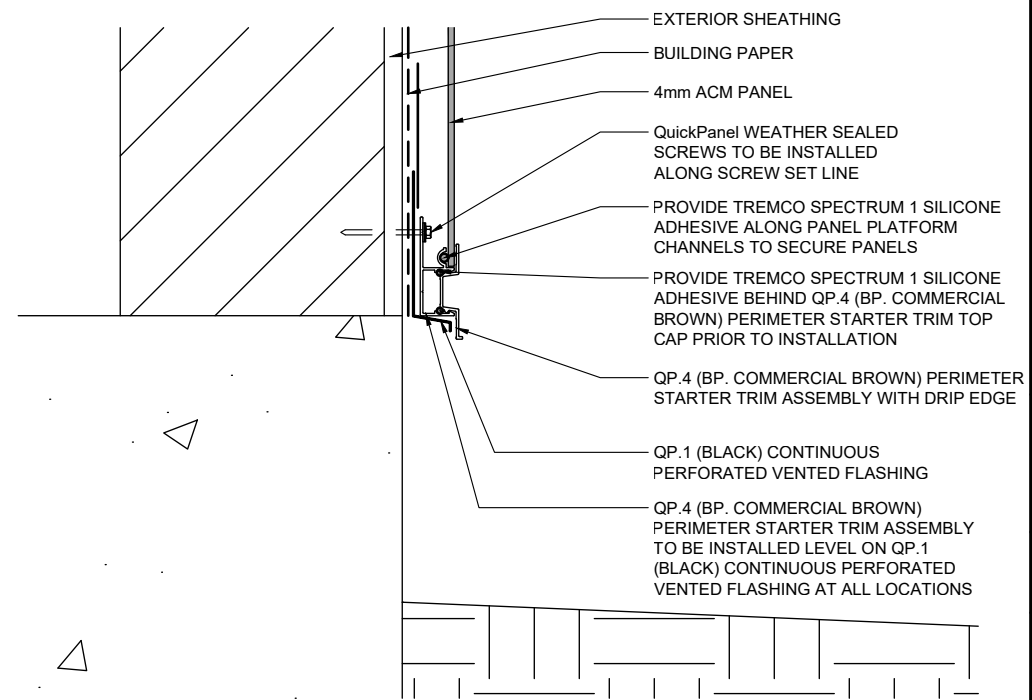

10 QuickPanel TYPICAL BASE SECTION

A3 SCALE: 3" = 1'-0"

4mm ACM QuickPanel System by EasyTrim Reveals

QuickPanel System Details

The contractor / builder must verify all dimensions on the job and report any discrepancy to the designer before proceeding with the work. Drawings are NOT to be scaled. All drawings and specifications are instruments of service and the copyright property of the designer and must be returned upon request.

DRAWN / REVISED BY:	REVIEWED BY:
DATE ISSUED:	DRAWING NUMBER:
PROJECT NUMBER:	<b>A3</b>
SCALE:	

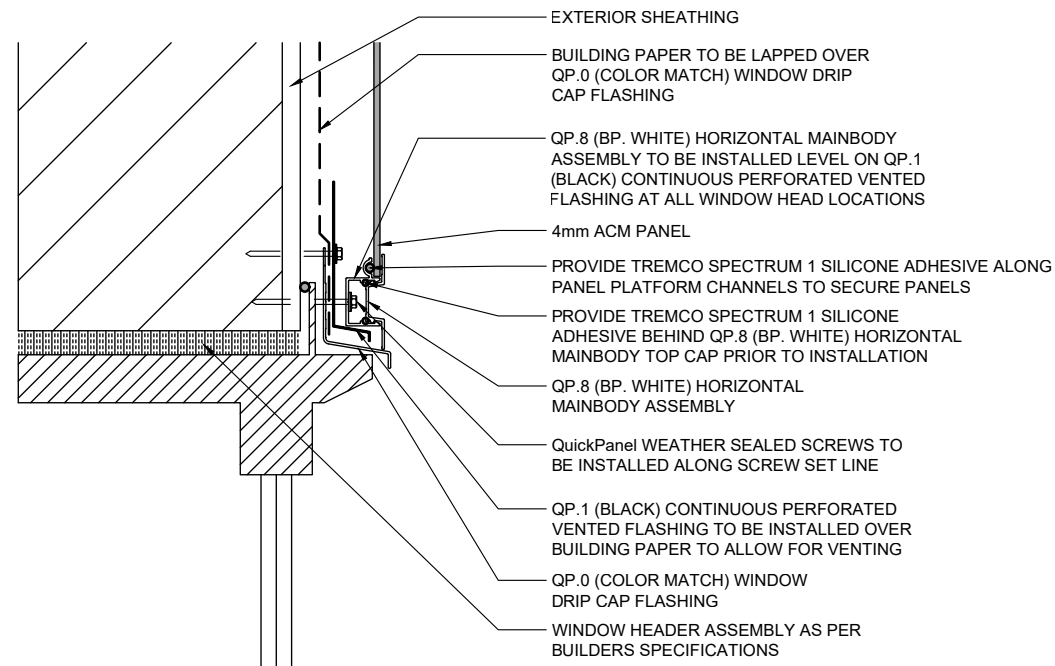

11

QuickPanel TYPICAL WINDOW HEAD SECTION

A4

SCALE: 3" = 1'-0"

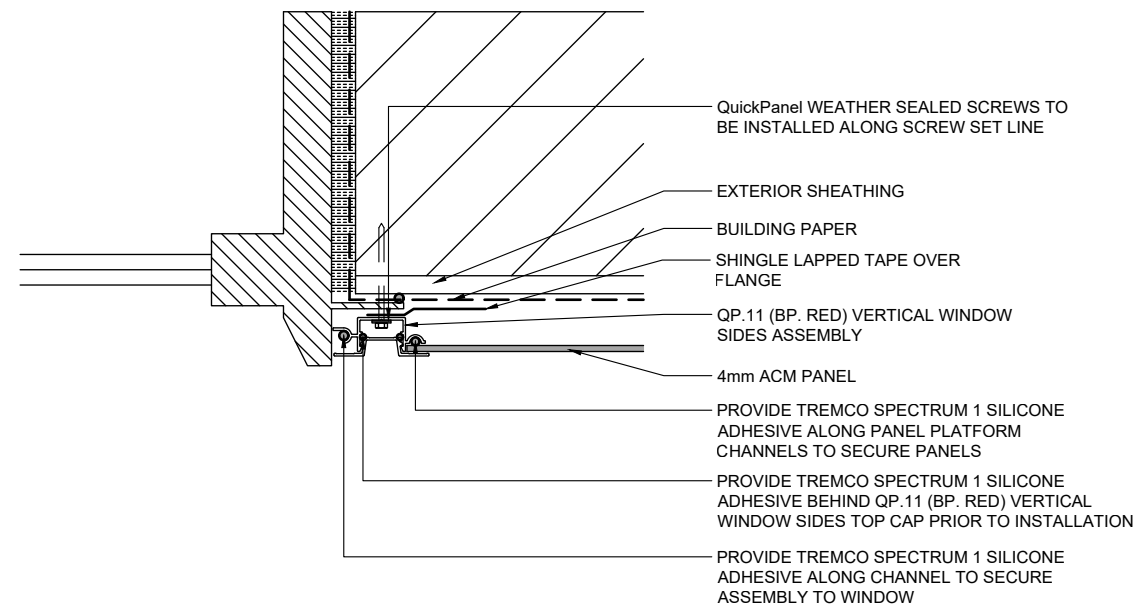

13

QuickPanel TYPICAL WINDOW JAMB DETAIL

A4

SCALE: 3" = 1'-0"

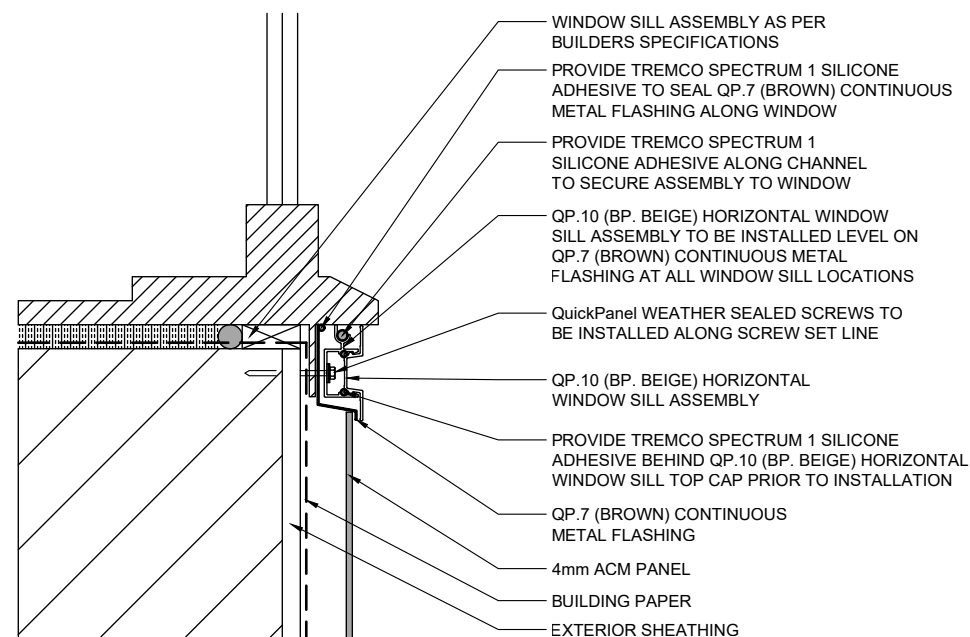

12

QuickPanel TYPICAL WINDOW SILL SECTION

A4

SCALE: 3" = 1'-0"

EASYTRIM REVEALS

1-877-973-8746  
www.easytrimreveals.com  
info@easytrimreveals.com

QuickPanel PROFILES:

- QP.0: WINDOW DRIP CAP FLASHING (COLOR MATCH)
  - QP.0-RSF: REVERSE SILL FLASHING (COLOR MATCH)
  - QP.1: CONTINUOUS PERFORATED VENTED FLASHING (BLACK)
  - QP.2: ARROW OUTSIDE CORNER ASSEMBLY (BP. GRAY)
  - QP.3: INSIDE CORNER (COLOR MATCH)
  - QP.4: PERIMETER STARTER TRIM ASSEMBLY (BP. COMMERCIAL BROWN)
  - QP.5: VERTICAL MAINBODY ASSEMBLY (BP. TAUPE)
  - QP.6: RAINSCREEN FURRING SPACERS (CHARCOAL)
  - QP.7: CONTINUOUS METAL FLASHING (BROWN)
  - QP.8: HORIZONTAL MAINBODY ASSEMBLY (BP. WHITE)
  - QP.9: SOFFIT TERMINATION ASSEMBLY (BP. BLUE)
  - QP.10: HORIZONTAL WINDOW SILL ASSEMBLY (BP. BEIGE)
  - QP.11: VERTICAL WINDOW SIDES ASSEMBLY (BP. RED)
  - QP.12: WALL PENETRATION ASSEMBLY (BP. GREEN)
  - QP.13: MULTI-ANGLE INSIDE CORNER ASSEMBLY (BP. COLOR MATCH)
  - QP.14: MULTI-ANGLE OUTSIDE CORNER ASSEMBLY (BP. COLOR MATCH)
  - QP.15: PERFORATED VENTED SOFFIT PLATE (COLOR MATCH)
  - QP.16: VERTICAL TERMINATION ASSEMBLY (BP. ORANGE)
  - QP.17: CORNER TERMINATION ASSEMBLY (BP. COLOR MATCH)
  - QP.18: CONTINUOUS COMPRESSION METAL FLASHING
  - QP.19: HORIZONTAL COMPRESSION ASSEMBLY
- 4mm ACM PANEL
- QuickPanel WEATHER SEALED SCREWS
- QuickPanel WEATHER TAPE
- TREMCO SPECTRUM 1 SILICONE ADHESIVE
- [NOTE: BP = BACKPLATE]

4mm ACM  
QuickPanel System  
by EasyTrim Reveals

QuickPanel System  
Details

The contractor / builder must verify all dimensions on the job and report any discrepancy to the designer before proceeding with the work. Drawings are NOT to be scaled. All drawings and specifications are instruments of service and the copyright property of the designer and must be returned upon request.

DRAWN / REVISED BY:	REVIEWED BY:
DATE ISSUED:	DRAWING NUMBER:
PROJECT NUMBER:	<b>A4</b>
SCALE:	

EASYTRIM REVEALS

1-877-973-8746  
 www.easytrimreveals.com  
 info@easytrimreveals.com

QuickPanel PROFILES:

- QP.0: WINDOW DRIP CAP FLASHING (COLOR MATCH)
  - QP.0-RSF: REVERSE SILL FLASHING (COLOR MATCH)
  - QP.1: CONTINUOUS PERFORATED VENTED FLASHING (BLACK)
  - QP.2: ARROW OUTSIDE CORNER ASSEMBLY (BP. GRAY)
  - QP.3: INSIDE CORNER (COLOR MATCH)
  - QP.4: PERIMETER STARTER TRIM ASSEMBLY (BP. COMMERCIAL BROWN)
  - QP.5: VERTICAL MAINBODY ASSEMBLY (BP. TAUPE)
  - QP.6: RAINSCREEN FURRING SPACERS (CHARCOAL)
  - QP.7: CONTINUOUS METAL FLASHING (BROWN)
  - QP.8: HORIZONTAL MAINBODY ASSEMBLY (BP. WHITE)
  - QP.9: SOFFIT TERMINATION ASSEMBLY (BP. BLUE)
  - QP.10: HORIZONTAL WINDOW SILL ASSEMBLY (BP. BEIGE)
  - QP.11: VERTICAL WINDOW SIDES ASSEMBLY (BP. RED)
  - QP.12: WALL PENETRATION ASSEMBLY (BP. GREEN)
  - QP.13: MULTI-ANGLE INSIDE CORNER ASSEMBLY (BP. COLOR MATCH)
  - QP.14: MULTI-ANGLE OUTSIDE CORNER ASSEMBLY (BP. COLOR MATCH)
  - QP.15: PERFORATED VENTED SOFFIT PLATE (COLOR MATCH)
  - QP.16: VERTICAL TERMINATION ASSEMBLY (BP. ORANGE)
  - QP.17: CORNER TERMINATION ASSEMBLY (BP. COLOR MATCH)
  - QP.18: CONTINUOUS COMPRESSION METAL FLASHING
  - QP.19: HORIZONTAL COMPRESSION ASSEMBLY
- 4mm ACM PANEL  
 QuickPanel WEATHER SEALED SCREWS  
 QuickPanel WEATHER TAPE  
 TREMCO SPECTRUM 1 SILICONE ADHESIVE  
 [NOTE: BP = BACKPLATE]

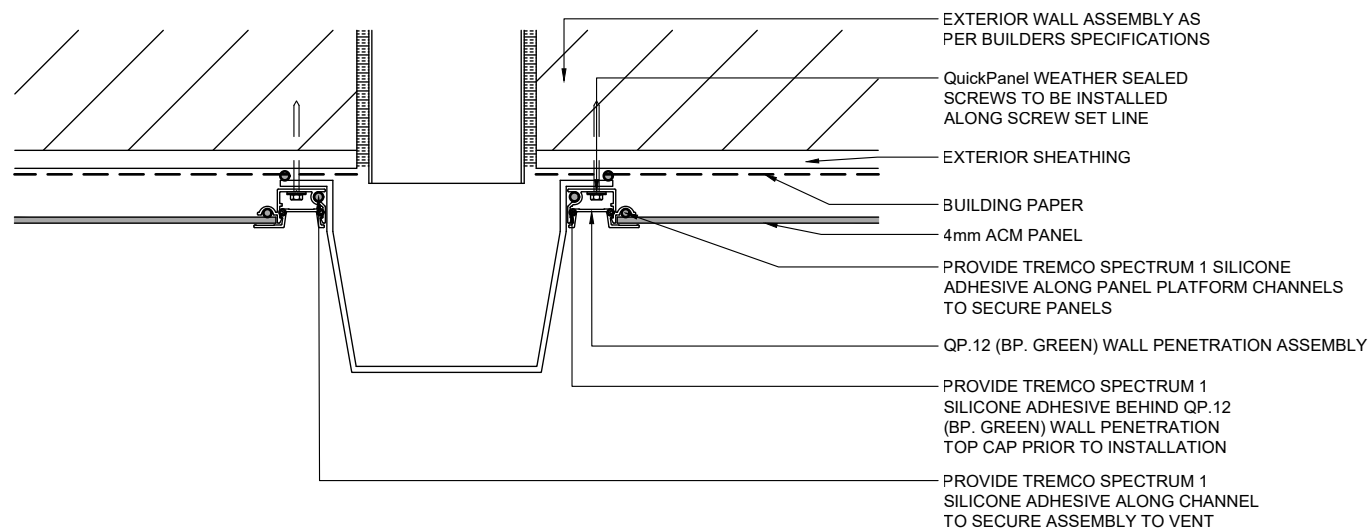

14

QuickPanel TYPICAL VENT/ WALL PENETRATION DETAIL

A5

SCALE: 3" = 1'-0"

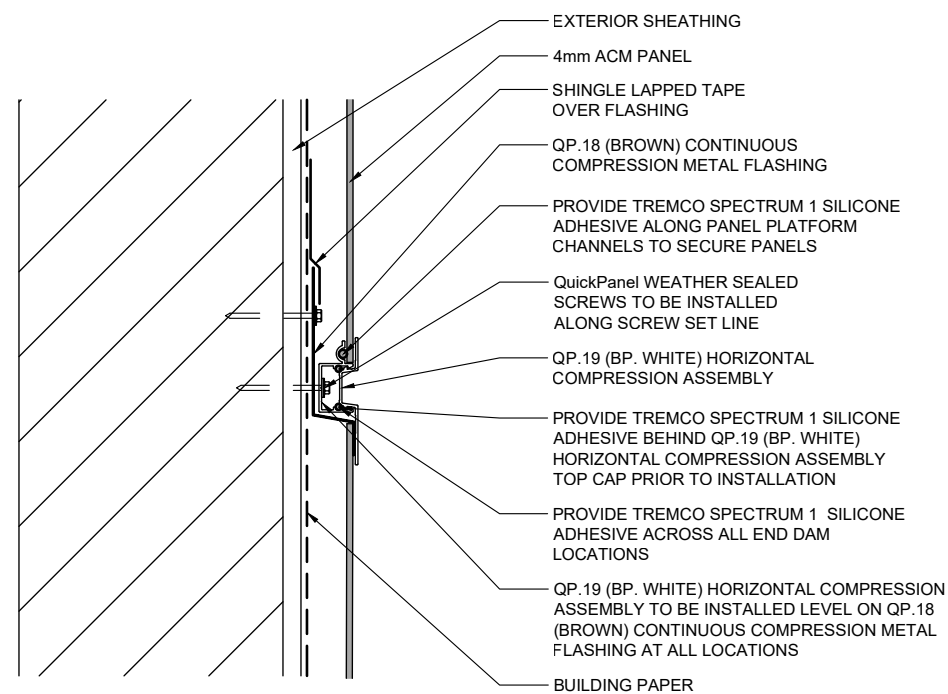

16

QuickPanel TYPICAL HORIZONTAL COMPRESSION SECTION

A5

SCALE: 3" = 1'-0"

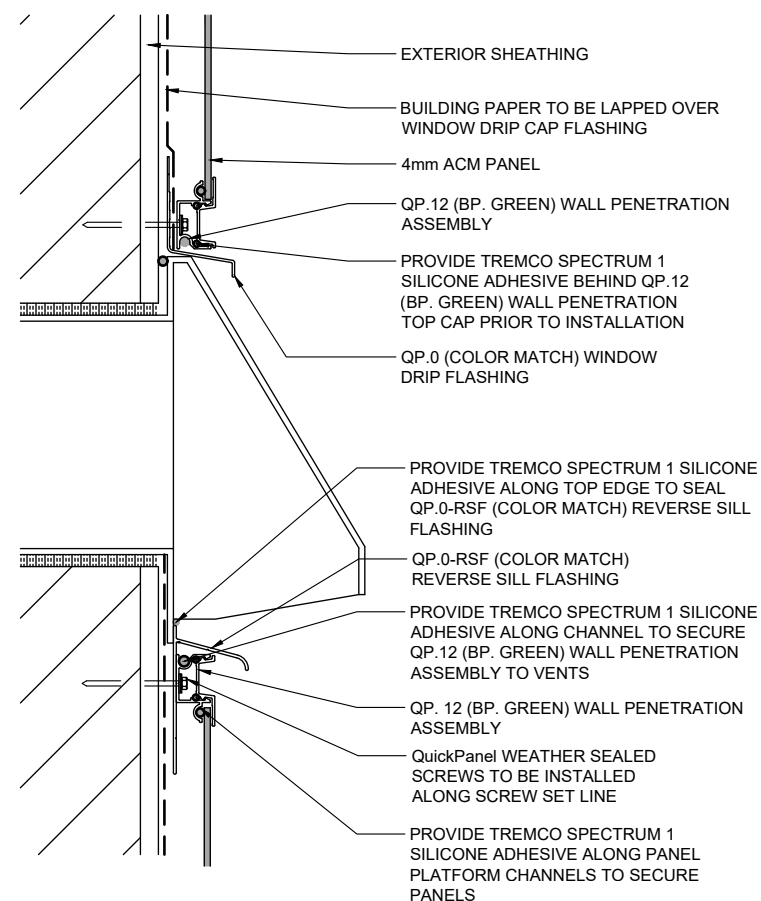

15

QuickPanel TYPICAL VENT/ WALL PENETRATION DETAIL

A5

SCALE: 3" = 1'-0"

DRAWN / REVISED BY:	REVIEWED BY:
DATE ISSUED:	DRAWING NUMBER:
PROJECT NUMBER:	<b>A5</b>
SCALE:	